

9

Adjust top rod (screw rod into or out of latch) until adjusted as shown.

With door closed:



Latch bolt **deadlocked** (will not push in)

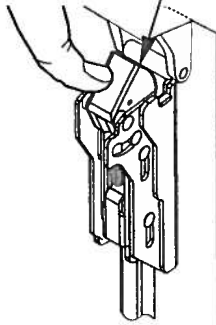

With door open:

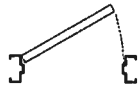

Latch bolt stays **retracted**

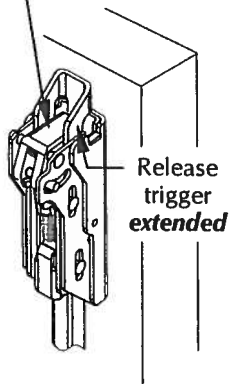

10

Install bottom strike, latch, and rod.

248L-4 strike

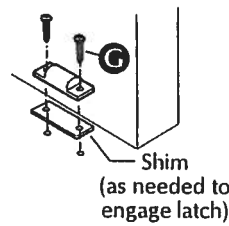

304L strike

Grout strike into floor

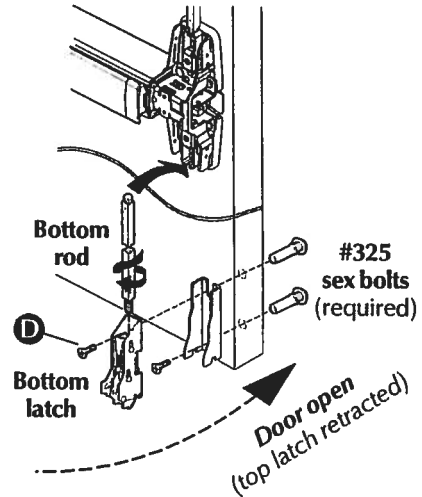
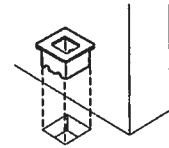

11

Adjust bottom rod with door open (top latch retracted).

With door open:



Latch bolt should **clear floor** and not bind on strike

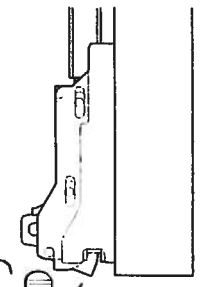

With door closed:

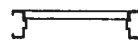

Latch bolt should be **deadlocked** (will not push in)

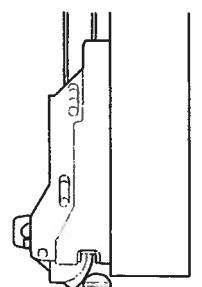

Open and close door a few times and check for deadlatching when door is closed

Readjust rods if needed

12

Install rod guides, and covers.

